

Explosion Protection

Marking UL844(North American) Class I,
 Div. 1, Groups C, D Class I, Div.
 2, Groups A,B,C,D Class II, Div.
 1, Groups E,F,G Class II, Div. 2,
 Groups F,G Class III

Marine Marking
 UL 1598A ABS

Other Rating
 IP 66
 IK 10



Materials

- Housing: Aluminum
- Lens: Tempered glass
- Hardware: stainless steel
- Mounting Bracket: stainless steel



Specification

Model	Wattage	Color Temperature	Voltage	Lumens	Warranty	CRI	Emergency Time
EX-20W D2YZDA	20W	2200K-7000K	AC100-277V (by driver or by IC) Or AC200-480V (<65W) Or DC12-48V	2800	5 years	80	3 Hours
EX-40W D2YZDA	40W			5600			
EX-60W D2YZDA	60W			8400			
EX-80W D2YZDA	80W		11200				
EX-100W DYZDA	100W		14000				
EX-150W DYZDA	150W		21000				
EX-200W DYZDA	200W		AC100-277V (by driver or by IC) Or AC200-480V Or DC12-48V	28000			

"D,D2"=Product series; "Y"=D or N: Dimmable or non-dimmable; "Z"=CCT,from 2200-7000K; "D"=Beam angle, D40 for 40°, D60 for 60°, D90 for 90°, D120 for 120°; A for glass info.: blank for flat glass.

Packing Information

Model	Quantity/Ctn	Dimension(MM)	Net weight(KG)	Gross weight(KG)
D	1	502×376×350	17.9	19.5
D2	1	400×385×335	7	9.5

Light Distribution

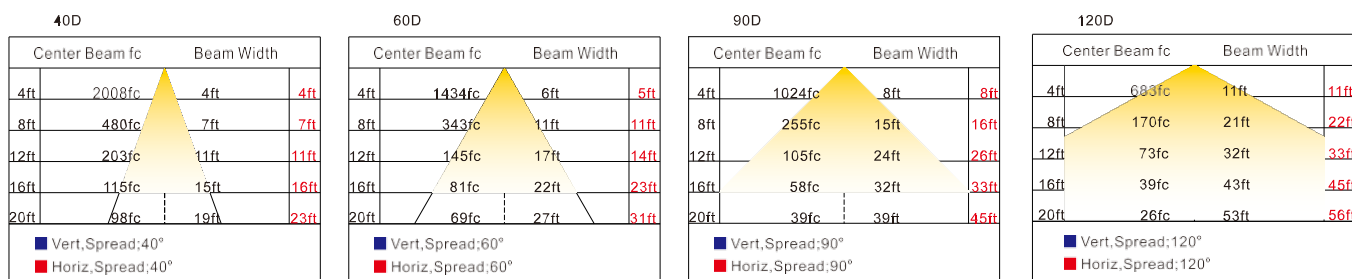

Features

- Working Temperature: $-40^{\circ}\text{C} \sim +55^{\circ}\text{C}$.
- High quality SMT LED and Meanwell Driver.
- Light-weight design by aircraft aluminum.
- Heavy-duty and high impact resistance.
- Three connection cable entry points.
- Replaceable LED board and drivers.
- Integrated junction box for driver with emergency back up.
- Dimmable and battery back up function available.
- Marine rating powder coated appearance treatment.
- Up to 5 years limited warranty option.
- Emergency Battery back up to three hours.
- Various installation ways for different applications.
- Glass lens or Glass with polycarbonate lens to make bigger beam angle.



Dimension

Unit: mm or inch

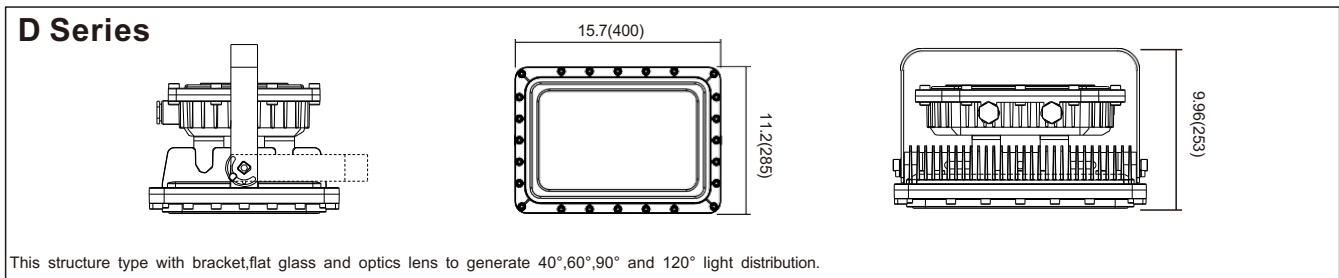
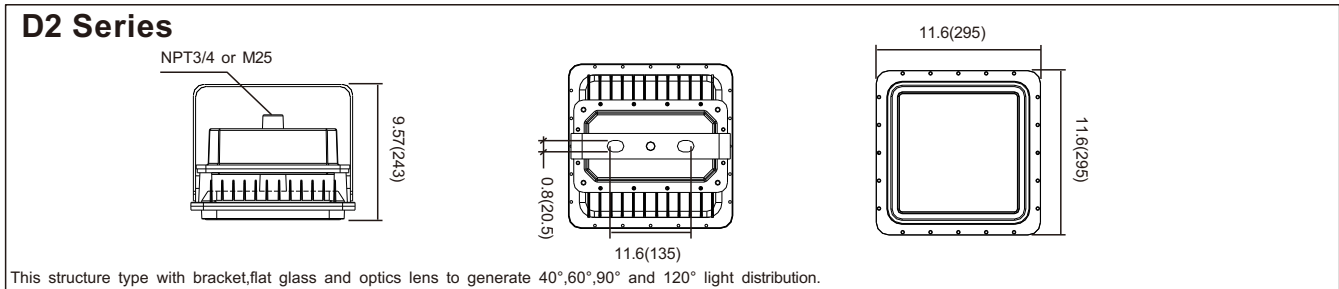

Mounting

No.1: Ceiling Mounting

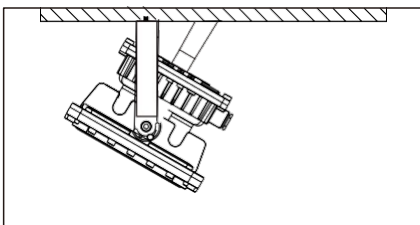

No.2: Wall Mounting

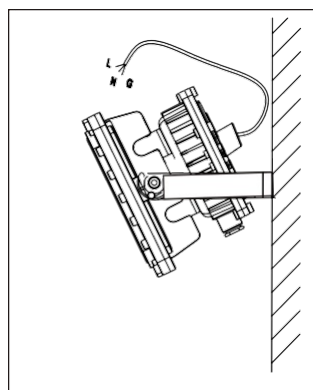

No.3: Pole Mounting

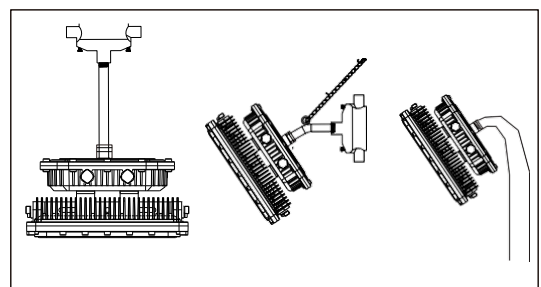



D



D2

Accessories

Junction Box



Bracket



Straight Pipe

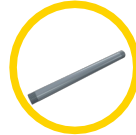

90° Arm to Junction box



Chain



Metal Conduit



Bended Pipe



25° Arm to Junction box

